



Operation Manual

Voyager IVTM

Nitrox System

If you have any questions on this equipment please contact Technical Support at:

Nuvair
2949 West 5th St.
Oxnard, CA 93030

Phone: 1-805-815-4044
FAX: 1-805-815-4196
Email: info@nuvair.com

Hours: Monday through Friday
8:00 AM to 5:00 PM PST USA

 **Warning**

This Operation Manual contains important safety information and should always be available to those personnel operating this equipment. Read, understand, and retain all instructions before operating this equipment to prevent injury or equipment damage.

Every effort was made to ensure the accuracy of the information contained within. Nuvair, however, retains the right to modify its contents without notice. If you have problems or questions after reading the manual, stop and call Nuvair at 1-805-815-4044 for information.

Table of Contents

Introduction

1.0 Introduction 4
2.0 Safety Warnings 5
3.0 Safety and Operation Precautions 7
4.0 Legal Precautions 8
5.0 Theory of Operation 9
6.0 Low Pressure Air Compressor Technical Data 10
7.0 High Pressure Compressor Technical Data 11
8.0 System Components 12
9.0 Nitrox System Specifications 13
10.0 Nitrox System Component Identification 14
11.0 System Drawing/Schematic 16
12.0 System Flow Chart 17

Setup, Operation, and Maintenance

13.0 Installing the Nitrox System 18
13.1 Precautions 18
13.2 Attaching Nitrogen Discharge Hose (Optional) 18
13.3 Electrical Power Connection 19
13.4 Check Compressor Lubricant Levels 20
13.5 Control Pane Description 20
14.0 Pre-Operation Instructions 21
14.1 Oxygen Analyzer Calibration 21
15.0 Producing Nitrox 23
15.1 Flow to Membrane and Setting Proper Pressure 23
15.2 Final Adjustments Before Pumping Nitrox 25
15.3 Pumping Nitrox 26
15.4 Pumping Air 26
15.5 Shutting Down 26
16.0 Nitrox Operational Notes 27
16.1 Correlation of Feed Air Pressure to Oxygen Content 27
16.2 Hot Fills 27
17.0 Maintenance 28
17.1 Daily Maintenance 28
17.2 Routine Maintenance 28
17.3 Compressor Lubricant 30
17.4 LP Feed Air Filtration 31
17.5 HP Compressor Filtration 33
17.6 Spare Parts List 34
17.7 Service Record Log 35

Appendix 36
Supply and Breathing Air Specifications 36
Filter Element Life Factors 36
Material Safety Data Sheets 37
Owner's Warranty Responsibilities 40
Warranty 41

Separate Manuals Included:
Nuair Pro O2™ Oxygen Analyzer Operation Manual
Rotair RVK 8-20 Compressor Manual
High Pressure Compressor Manual

1.0 Introduction

Nuvair has taken extreme care in providing you with the information you will need to operate this system. However, it is up to you to carefully read this manual and make the appropriate decisions about system safety.

This manual will assist you in the proper set-up, operation and maintenance of the Nuvair Voyager IV™ Nitrox System. Be sure to read the entire manual.

Throughout this manual we will use certain words to call your attention to conditions, practices or techniques that may directly affect your safety. Pay particular attention to information introduced by the following signal words:

Danger

Indicates an imminently hazardous situation, which if not avoided, will result in serious personal injury or death.

Warning

Indicates a potentially hazardous situation, which if not avoided, could result in serious personal injury or death.

Caution

Indicates a potentially hazardous situation, which if not avoided, may result in minor or moderate injury. It may also be used to alert against unsafe practices.

Notice

Notifies people of installation, operation or maintenance information which is important but not hazard-related.

2.0 Safety Warnings

 **Warning**

This equipment is used to provide breathing gas for the purpose of underwater life support. Read this manual in its entirety. Failure to heed the warnings and cautions contained in this document may result in severe injury or death.

 **Warning**

The equipment you will be using to manufacture Nitrox (oxygen rich air) will expose you to both low and high-pressure gas. Gas, even under moderate pressures, can cause extreme bodily harm. Never allow any gas stream to be directed at any part of your body.

 **Warning**

Any pressurized hose can cause extreme harm if it comes loose or separates from its restraint (or termination) while under pressure and strikes any part of your body. Use appropriate care in making and handling all gas connections.

 **Danger**

Pure nitrogen is a colorless, odorless, tasteless gas that will not support life. Breathing gas mixtures containing more than 84% nitrogen at surface pressures will lead to unconsciousness and may cause death.

 **Warning**

The nitrogen discharge from the Membrane System must be vented to the exterior of any closed building, boat, or similar enclosed space. Breathing gas mixtures containing more than 84% nitrogen at surface pressure will lead to unconsciousness and may cause death.

 **Warning**

Do not use any form of mineral oil or synthetic lubricant not rated for Nitrox in any Compressor in this system. Use only the recommended Nitrox Compressor Lubricant. Never mix the Nitrox Compressor Lubricant with other lubricants. Remove all existing lubricant and replace with the proper Nitrox Compressor Lubricant prior to installing the Membrane System. The use of improper lubricants can lead to fire or explosions, which may cause serious personal injury or death.

 **Warning**

Do not use this system to produce Nitrox mixtures containing more than 40% oxygen. Pumping Nitrox mixtures with higher concentrations of oxygen may lead to fires or explosions, which can cause serious personal injury or death.

 **Warning**

The use of enriched air Nitrox does not eliminate the risk of decompression sickness (DCS) in diving. Decompression sickness can lead to permanent disability or death.

 **Warning**

Do not pump Nitrox mixtures at pressures above the HP Compressor manufacturer's rating, and never above 3600 P.S.I. (250 bar). The system is not rated for pressures above 3600 P.S.I. (250 bar). Higher pressures may lead to explosions which may cause serious personal injury or death.

 **Caution**

Ambient room temperature should never exceed 100°F (38°C) during operation of the Nitrox System. Operation at higher temperatures may lead to system damage and malfunction. A damaged membrane will not produce the correct Nitrox mixture which can lead to severe personal injury if the gas is used for diving purposes without proper analysis.

3.0 Safety And Operation Precautions

Because a compressor is a piece of machinery with moving and rotating parts, the same precautions should be observed as with any piece of machinery of this type where carelessness in operations or maintenance is hazardous to personnel. In addition to the many obvious safety precautions, those listed below must also be observed:

- 1) Read all instructions completely before operating any compressor or Nitrox System.
- 2) For installation, follow all local electrical and safety codes, as well as the National Electrical Code (NEC) and the Occupational Safety and Health Administration (OSHA) standards.
- 3) Electric motors must be securely and adequately grounded. This can be accomplished by wiring with a grounded, metal-clad raceway system to the compressor starter; by using a separate ground wire connected to the bare metal of the motor frame; or other suitable means.
- 4) Protect all power cables from coming in contact with sharp objects. Do not kink power cables and never allow the cables to come in contact with oil, grease, hot surfaces, or chemicals.
- 5) Make certain that power source conforms to the requirements of your equipment.
- 6) Pull main electrical disconnect switch and disconnect any separate control lines, if used, before attempting to work or perform maintenance. "Tag Out" or "Lock Out" all power sources.
- 7) Do not attempt to remove any parts without first relieving the entire system of pressure.
- 8) Do not attempt to service any part while System is in an operational mode.
- 9) Do not operate the System at pressures in excess of its rating.
- 10) Do not operate compressor at speeds in excess of its rating.
- 11) Periodically check all safety devices for proper operation. Do not change pressure setting or restrict operation in any way.
- 12) Be sure no tools, rags or loose parts are left on the Nitrox System.
- 13) Do not use flammable solvents for cleaning the Air Inlet Filters or elements and other parts.
- 14) Exercise cleanliness during maintenance and when making repairs. Keep dirt away from parts by covering parts and exposed openings with clean cloth or Kraft paper.
- 15) Do not operate the compressor without guards, shields, and screens in place.
- 16) Do not install a shut-off valve in the compressor discharge line, unless a pressure relief valve, of proper design and size, is installed in the line between the compressor unit and shut-off valve.
- 17) Do not operate in areas where there is a possibility of inhaling carbon monoxide, carbon dioxide, nitrogen, or flammable or toxic fumes.
- 18) Be careful when touching the exterior of a recently run electric, gasoline, or diesel motor - it may be hot enough to be painful or cause injury. With modern motors this condition is normal if operated at rated load - modern motors are built to operate at higher temperatures.
- 19) Inspect unit daily to observe and correct any unsafe operating conditions found.
- 20) Do not "play around" with compressed air, nor direct air stream at body, because this can cause injuries.
- 21) Compressed air from this machine absolutely must not be used for food processing or breathing air without adequate downstream filters, purifiers and controls and periodic air quality testing.
- 22) Always use an air pressure-regulating device at the point of use, and do not use air pressure greater than marked maximum pressure.
- 23) Check hoses for weak or worn conditions before each use and make certain that all connections are secure.

The user of any compressor or Nitrox System manufactured by Nuair is hereby warned that failure to follow the preceding Safety and Operation Precautions can result in injuries or equipment damage. However, Nuair does not state as fact or does not mean to imply that the preceding list of Safety and Operation Precautions is all-inclusive, and further that the observance of this list will prevent all injuries or equipment damage.

4.0 Legal Precautions

It is highly recommended that a Nitrox fill log be maintained when filling Scuba cylinders to document the following information. This log must be of permanent binding style with no loose pages.

- ◆ Fill date and time of day
- ◆ Tank Number
- ◆ Supplier's check of oxygen content (%O₂) plus signature and date
- ◆ User's check of oxygen content (%O₂) plus signature and date
- ◆ Fill Pressure
- ◆ MOD (Maximum Operating Depth) in user's handwriting
- ◆ Nitrox certifying agency and card number

5.0 Theory of Operation

The Voyager IV™ Nitrox System is a turnkey package that produces oxygen-rich air (Nitrox) and then compresses it with a High Pressure (HP) Compressor to fill Scuba Tanks or storage cylinders. The package is designed to be fully automatic, with a quieted enclosure for noise reduction and protection from moving parts while it is running. Although it is described as the “Nitrox Compressor”, it can also be used to pump air.

The Nitrox System allows for efficient and cost effective Nitrox production using electric power, without the hazards or expense of blending with stored high-pressure oxygen (O₂). Instead, the system uses a Semi-Permeable Membrane to produce Nitrox from air. A portion of the nitrogen in air is separated out, leaving an oxygen rich Nitrox mixture.

The Voyager IV™ uses a Rotary Screw LP Compressor, Air/Oil Aftercooler, Refrigerated Air Dryer, and Filtration to provide the Membrane System with a source of clean, pressurized feed air for separation. The air is filtered to CGA Grade D or better air quality prior to entering the Membrane System so it will not damage or plug the Membrane fibers. Specifications for Grade D air are provided in the Appendix.

The Voyager IV™'s Membrane System is rated for a maximum feed air pressure of 300 P.S.I. (21 bar) and has been configured to work well with the 175 P.S.I. (12 bar) maximum pressure delivered by the LP Compressor. A Back Pressure Regulator is used to adjust the amount of air the screw compressor produces to meet the appropriate levels for various %O₂ Nitrox production. The air is then heated to a temperature that provides stability over a wide range of ambient conditions, is optimal for Membrane permeation, and prevents moisture condensation.

The heated air enters the Membrane, which is made up of thousands of miniature hollow fibers. The walls of these fibers are semi-permeable and designed for different gases to move through them (or permeate) at different speeds. The resulting gas mixture is known as the “permeate”. As air flows through the hollow fibers, both oxygen and nitrogen permeate through the fiber walls. The oxygen permeates faster than the nitrogen, which produces permeate with oxygen content greater than air. The gas that reaches the end of the hollow fibers without permeating is almost entirely nitrogen and is discharged. The flow rate of this discharge is set by the factory via a fixed orifice, which controls the permeate to contain a constant 44% O₂ under normal operating conditions.

The permeate is a concentrated mixture that must be diluted with additional air prior to entering the HP Compressor. It exits the Membrane at ambient to slightly negative pressure and travels into the Mixing Tube, where it mixes homogeneously with filtered outside air. The amount of dilution, and thus final %O₂, is obtained by adjusting the amount of air produced by the compressor and supplied to the membrane, with the Back Pressure Regulator. As air flow to the membrane is increased, permeate flow increases and a higher %O₂ Nitrox is produced. As air flow to the membrane is decreased, permeate flow decreases, compressor intake air increases, and a lower %O₂ Nitrox is produced.

This relationship between permeate flow and intake air flow exists because the total of these two flow rates will always equal the intake flow rate demanded by the HP Compressor. The resulting Nitrox mixture is analyzed for %O₂ before entering the HP Compressor for approximate content and again when pumping Nitrox for precise content. The HP Compressor pumps the Nitrox to a maximum pressure of 3600 psi (250 bar) to fill Scuba Tanks or storage cylinders.

A unique feature of NuVair Nitrox Systems is that the feed air pressure that correlates to a specific Nitrox %O₂ is repeatable. For example, if your HP Compressor pumps 36% O₂ when the feed air pressure is at 125 P.S.I. (9 bar), then adjusting the Back Pressure Regulator to 125 P.S.I. (9 bar) during the next use will produce the same mixture.

6.0 Low Pressure Compressor Technical Data

See Separate Manual for Rotair RVK2-130

Capacity and Power Consumption:

Normal working pressure – 90-175 P.S.I. (6-12 bar)
Capacity at normal working pressure – 60 cfm (1700 l/min)
Shaft power at normal working pressure – 20 hp (15 kW)
Maximum working pressure – 175 P.S.I. (12 bar)
Minimum working pressure – 44 P.S.I. (3 bar)
Idling shaft power consumption – 4.8 hp (3.6 kW)
Transmission – Belt drive

Cooling:

Allowed ambient temperature – 32-104°F (0-40°C)
Compressed air temperature above cooling medium temperature – 50°F (10°C)
Cooling air flow – 1692 cfm (0.8 m³/s)
Maximum cooling air pressure drop – 0.12 in H₂O (30 Pa)
Cooling air temperature rise – 57°F (14°C)
Oil cooler heat rejection – (12.2 kW)
Aftercooler heat rejection – (1.7 kW)

3 phase Motor Class F ODP and Electrical Values:

Motor - F class, 20hp (15 kW)
Speed of rotation – 2930 rpm
Fuse (max) – 230v=63 / 400v=50 / 690v=18
Compressor current – 230v = 54amps / 400v= 31amps / 690v= 18amps
Control voltage – 230 V

General Technical Data:

Oil Capacity 4 liters
Maximum Oil Content in Air– 3 mg/m³

7.0 High Pressure Compressor Technical Data
See Separate Manual for Coltri HP Compressor
Specs reflect “MCH 30” Model

Capacity and Power Consumption:

- Normal working pressure – 3600 P.S.I. (250 bar)
- F.A.D. Flow 17.5cfm (495 l/min)
- Charging Rate – 21 SCFM (595 l/min)
- Compressor speed of rotation – 950 rpm
- Maximum working pressure – Air 6000 P.S.I. (425 bar), Nitrox 3600 P.S.I. (248 bar)
- Transmission – Belt drive

Cooling:

- Allowed ambient temperature – 32-105°F (0-40°C)
- Air Cooled Interstage & Aftercooler

Motor and Electrical Values:

- Motor - 15hp (11kw) 3 phase
- Speed of rotation – 3450 rpm @ 60Hz or 2850rpm @50Hz
- Compressor current 230V 50-60 Hz/three phase – 31A
 440V 50-60 Hz/three phase – 16A

General Technical Data:

- Number Of Stages – 4
- Number Of Cylinders – 4
- Lubrication – Pressure & Splash Lubricated
- Oil Quantity – 4.25 qt. (5 liters)
- HP Filtration Rating – CGA Grade E, 65,000 cu. ft. at 68°F (20°C)
- Condensate Drains – Automatic & Manual Interstage & Final
- Fill Pressure Stop – Automatic & Manual
- Low Oil Level Shutdown
- High Temperature Shutdown
- Interstage Pressure Gauges

8.0 System Components

- Low Pressure Compressor, including:
 - ◆ Magnet Motor Starter
 - ◆ Hour Meter
 - ◆ External Lubricant Sight Gauge, Fill, and Drain
 - ◆ Nuvair 546™ Food Grade Rotary Screw Compressor Lubricant
 - ◆ Large oil/air cooler with exhaust fan
- Refrigerated Air Dryer
 - ◆ Automatic Condensate Drain
- Back Pressure Regulator that controls LP compressor feed air supply
 - ◆ Supply Air Pressure Gauge 90-165 P.S.I. (6-11 bar) depending on Nitrox %O₂
- Low Pressure Feed Air Filtration, Grade D Breathing Air, including four stages:
 - ◆ Coalescing & Particle Removal to 1 micron, auto drain, liquid level indicator
 - ◆ Water & Oil Vapor Removal to 0.01 micron, auto drain, liquid level & service life indicators
 - ◆ Oil Vapor Removal to 0.003 PPM
- Heater including: (optional) not supplied with Nitrox Manager
 - ◆ Thermostat Control
 - ◆ Digital Temperature Gauge
 - ◆ Pressure Switch
 - ◆ 200 P.S.I. (14 bar) ASME Over Pressure Relief
- Semi-Permeable Membrane
- Mixing Tube & Air Intake Filter
- Nuvair Pro O₂ Remote™ Permeate Oxygen Analyzer
- Nitrogen Discharge
- Nuvair Pro O₂™ Fill Oxygen Analyzer, including:
 - ◆ High Pressure>Low Pressure Regulator
 - ◆ Flow Restrictor, 1 - 5 L/min
- High Pressure Compressor, including
 - ◆ Magnet Motor Starter
 - ◆ Hour Meter
 - ◆ Automatic Condensate Drains
 - ◆ Automatic Fill Pressure Stop
 - ◆ External Lubricant Sight Gauge, Fill, and Drain
 - ◆ Nuvair 455™ Food Grade Compressor Lubricant
- High Pressure Filtration, Grade E Breathing Air
- Air/Nitrox Quality Analysis Kit

9.0 Nitrox System Specifications

LP Compressor	Delivery @ 175 P.S.I. (12 bar)	60 cfm FA (1700 L/min)
	Horsepower – Electric	20 hp (15 kW)
Physical Specifications	Height	67 in (170 cm)
	Width	62 in (158 cm)
	Depth	35 in (89 cm)
	Weight	1450 lb (658 kg)
Full Load Amps	230V/E3/50-60 Hz	102A
	440V/E3/50-60 Hz	51A
Membrane Input	Operating Pressure Range	90-185 psi (6-12 bar)
	Maximum Input Pressure	300 psi (21 bar)
	Feed Air Volume Range	13-60 scfm (354-1700 L/min)
	LP Feed Air Quality	Grade D
	Optimum Temperature	110 +/- 5°F (43 +/- 3°C)
	Nitrox %O ₂ Range	24 - 40%
HP Compresso	Charging Rate	21 SCFM (595 L/min)
	Horsepower – Electric	15 hp (11 kW)

10.0 Nitrox Voyager IV System Component Identification

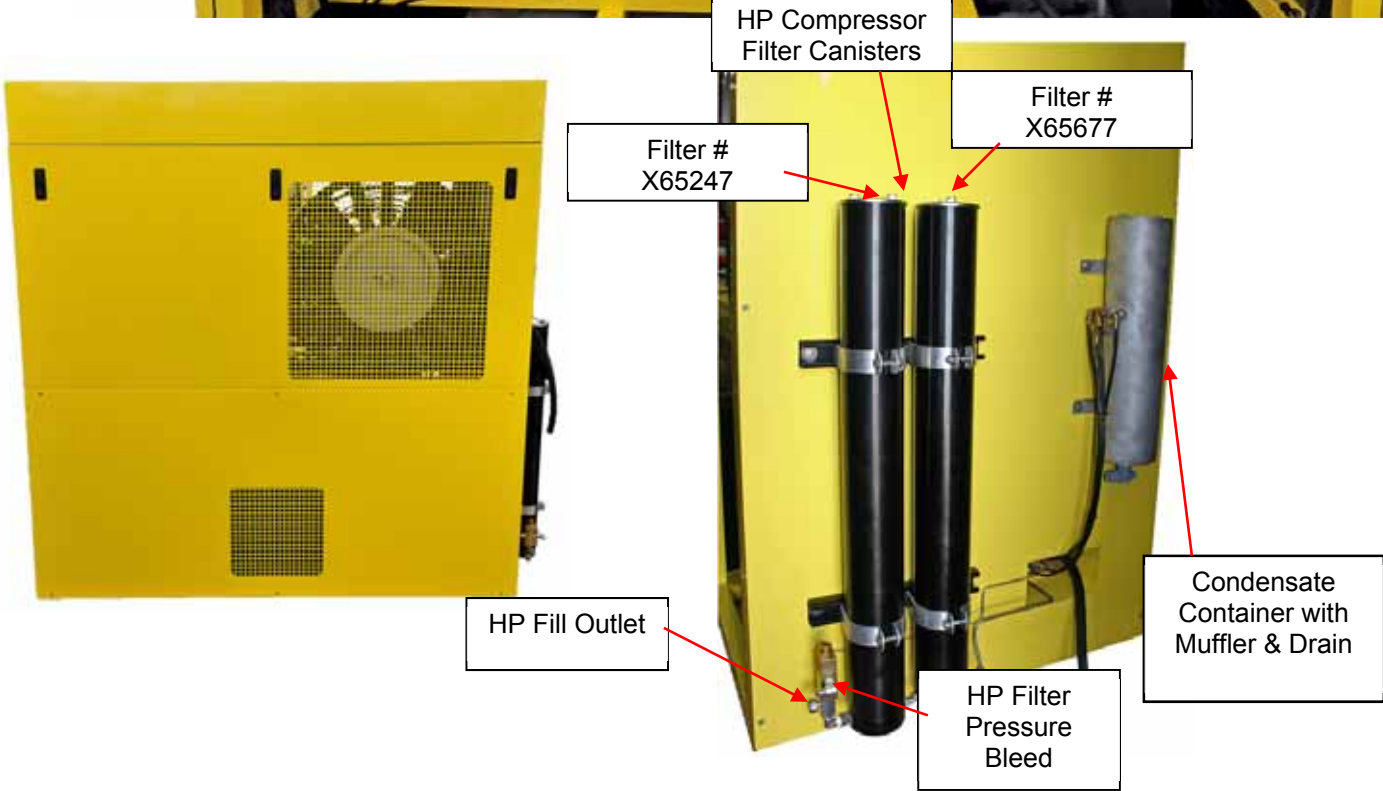
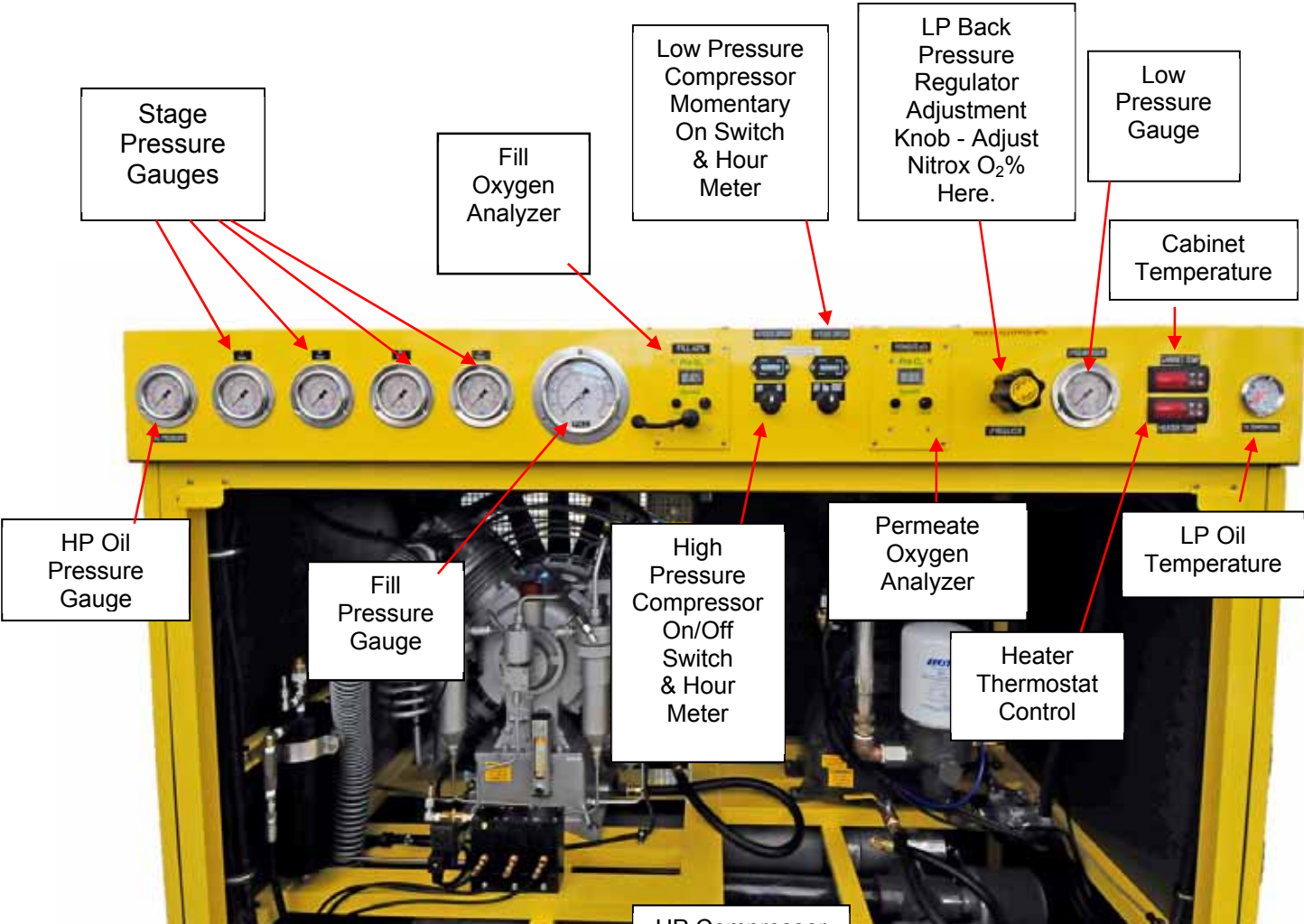

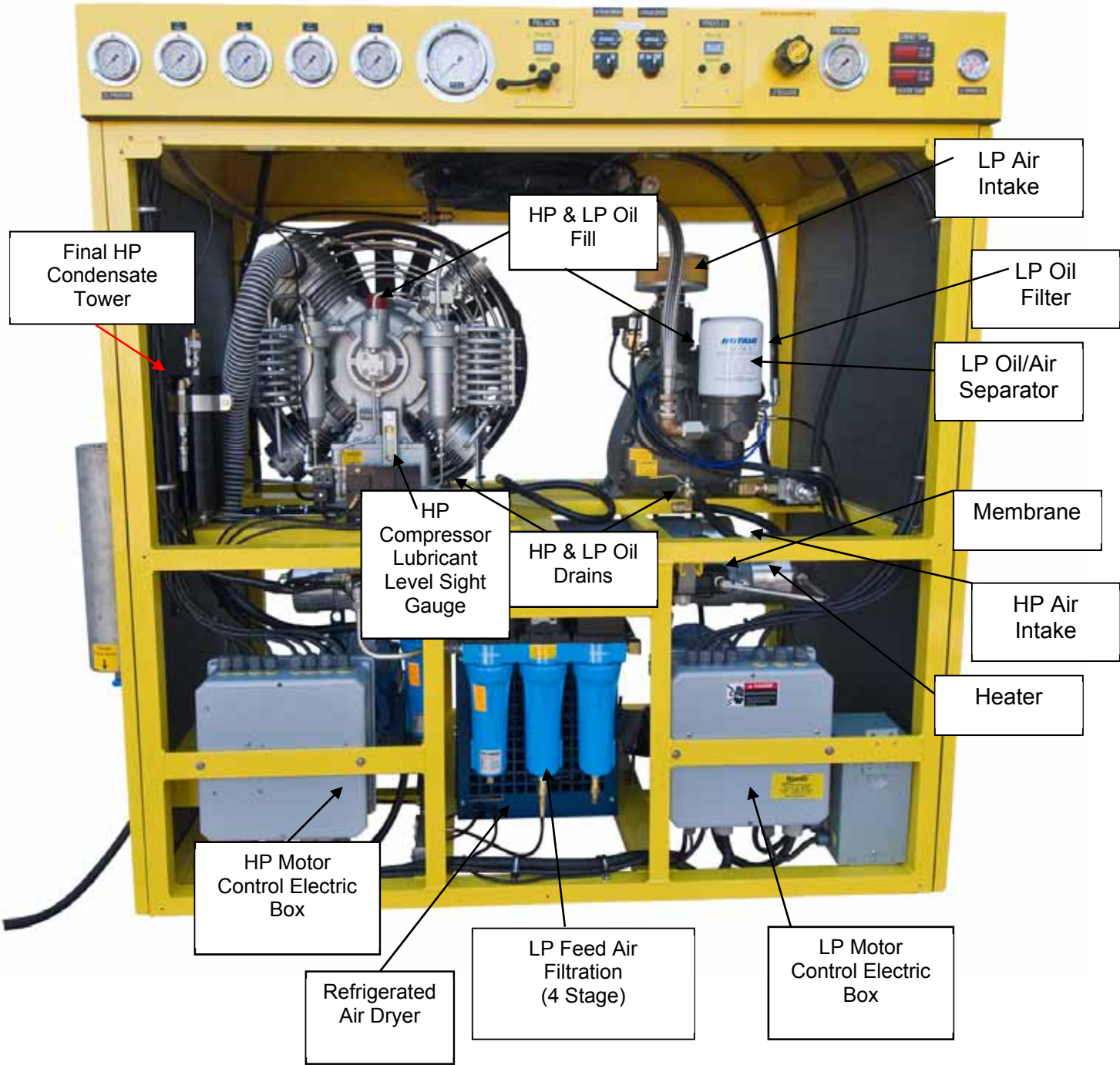

11.0 System Drawing / Schematic

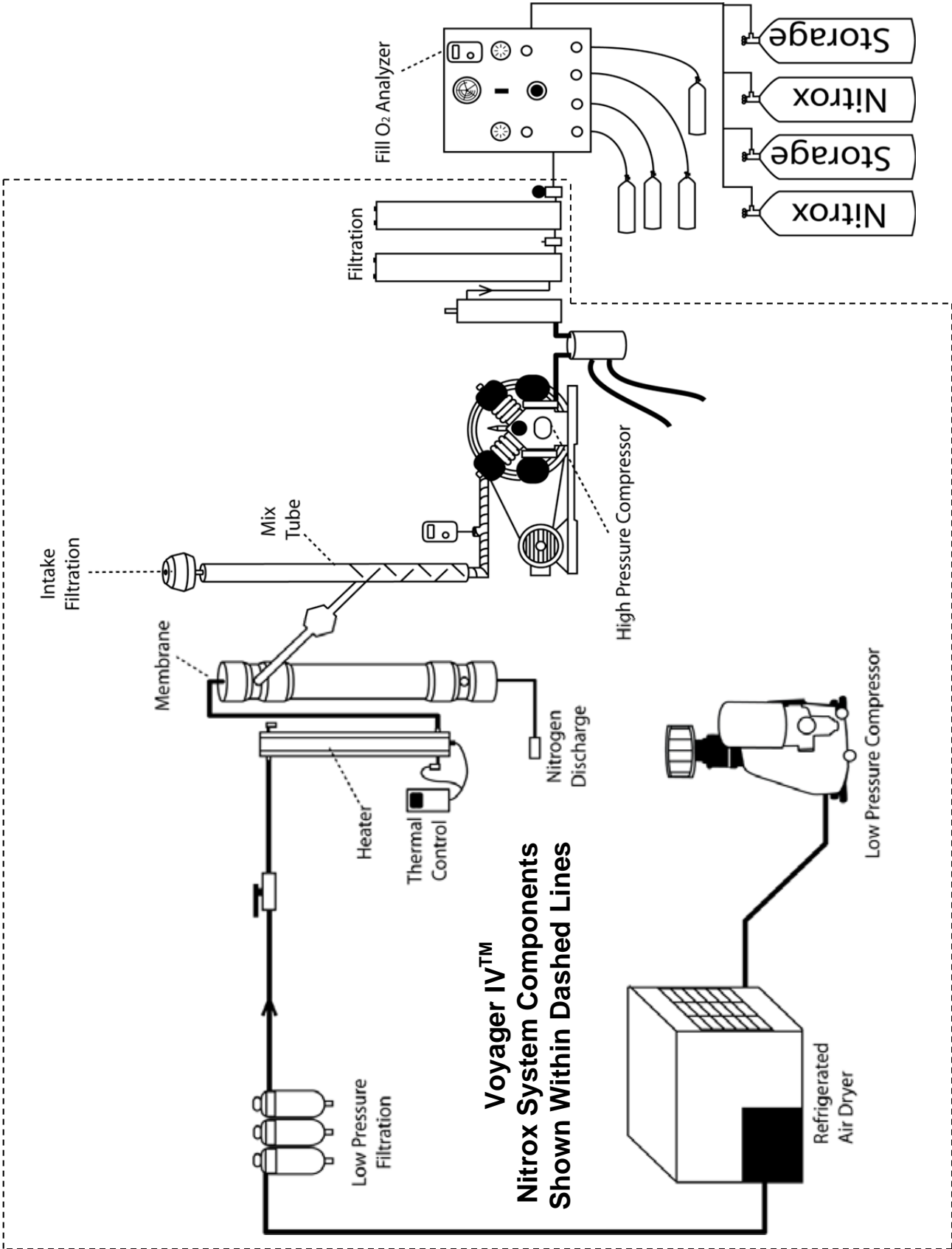

12.0 System Flow Chart

Voyager IV™ Nitrox System Components Shown Within Dashed Lines

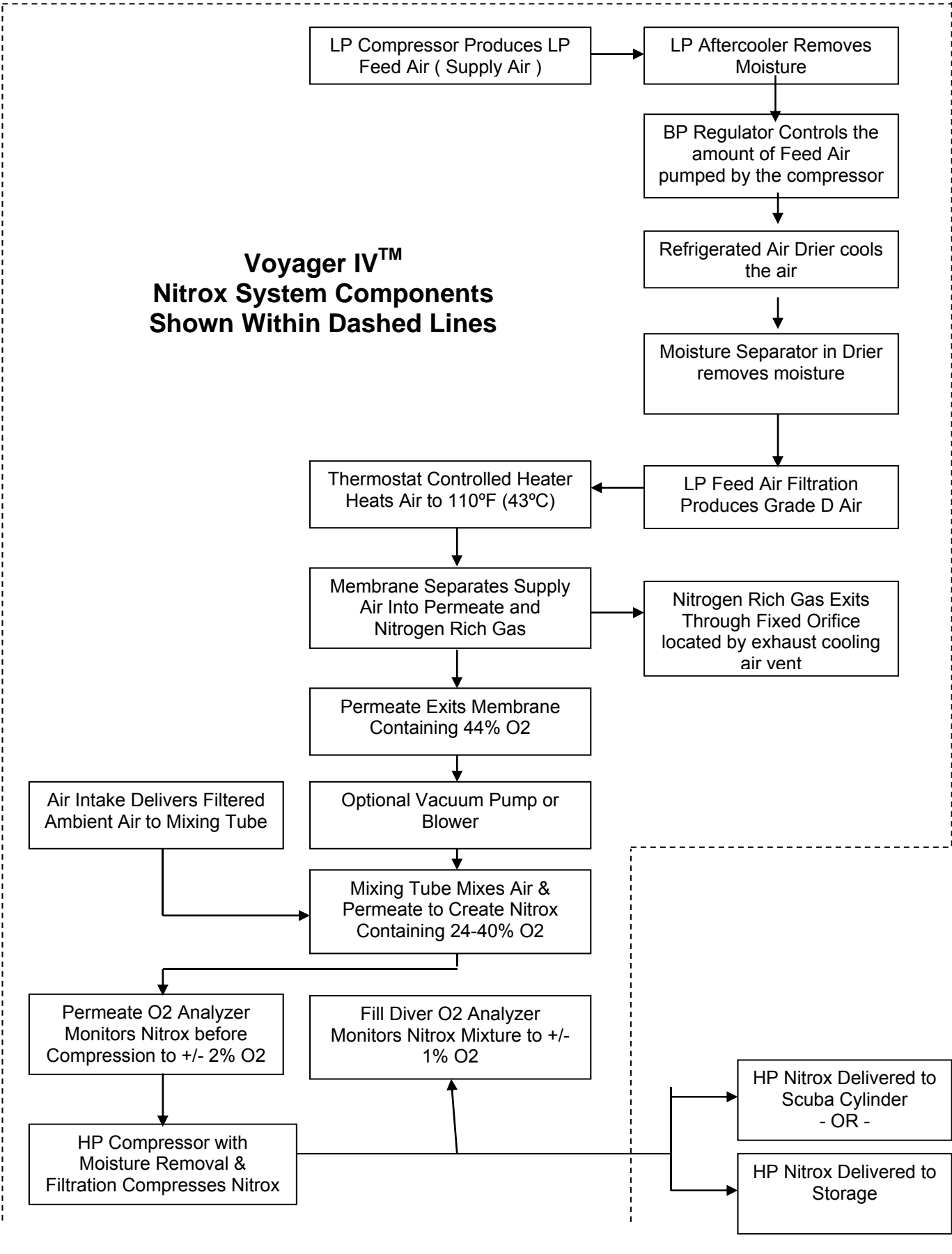

13.0 Installing the Voyager IV Nitrox System

Notice

If any information in this manual conflicts with any of the other manuals call Nuair before proceeding.

Caution

Ambient room temperature should never exceed 100°F (38°C) during operation of the Nitrox System. Operation at higher temperatures may lead to system damage and malfunction. A damaged membrane will not produce the correct Nitrox mixture which can lead to severe personal injury if the gas is used for diving purposes without proper analysis.

13.1 Precautions

1. Please read all information supplied before physically installing the Nitrox System.
2. Unpack the system and remove from the pallet. Visually inspect the system to make sure there has been no damage during shipping. If damaged, please call Nuair to file a damage report. Please take photos and supply detailed information about the damage.
3. Place the system in a location that allows a minimum spacing of 18" from adjacent walls. Select a location where ambient room temperature will never exceed 100°F (38°C).
4. The Heater Thermostat has been set in the factory. Do not adjust.

13.2 Nitrogen Discharge Hose

The nitrogen discharge from the Membrane on the Voyager IV exits next to the exhaust air fan. The fan pushes over 3000 cfm of exhaust air and as long as the fan is functioning there will be no need for an outside optional discharge, unless installed in a properly ventilated room.



Warning

Pure nitrogen is a colorless, odorless, tasteless gas that will not support life. Breathing gas mixtures containing more than 84% nitrogen at surface pressures will lead to unconsciousness and may cause death.

Warning

The nitrogen discharge from the Membrane should be vented to a well-ventilated room or to open air with good circulation. Failure to isolate the discharge from the air intake of the Membrane System or LP Compressor could lead to incorrect Nitrox mixtures, resulting in serious personal injury or death. If you allow this pure nitrogen to accumulate in an enclosed space, anyone entering this space will quickly lose consciousness and will die if not immediately resuscitated.

13.3 Electrical Power Connection

Warning

Never use extension cords to provide power to your Nitrox System. The system must be properly wired according to national and local electrical codes by a qualified electrician. Improper wiring may lead to fires, which can cause serious personal injury or death.

Prior to making the electrical power connection, check all system specifications provided in this manual. When working on the Nitrox System the main breaker at the power source must be “locked out” in the Off position. The Nitrox System has electrical protection for the Compressor Motor and Membrane System Heater located inside the motor starter compartment.

Amperage Load for System

- ◆ Approximately 102 A for 230 V three phase service
- ◆ Approximately 51 A for 440 V three phase service

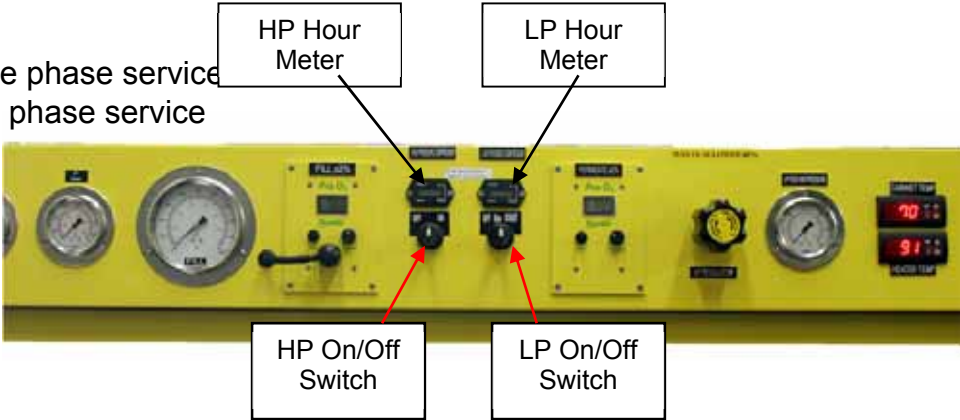

Compressor Rotation Check

Always turn on (bump) starter for both LP and HP Compressors and run motor very briefly to check for proper direction of rotation (see arrow on belt guard and flywheel).

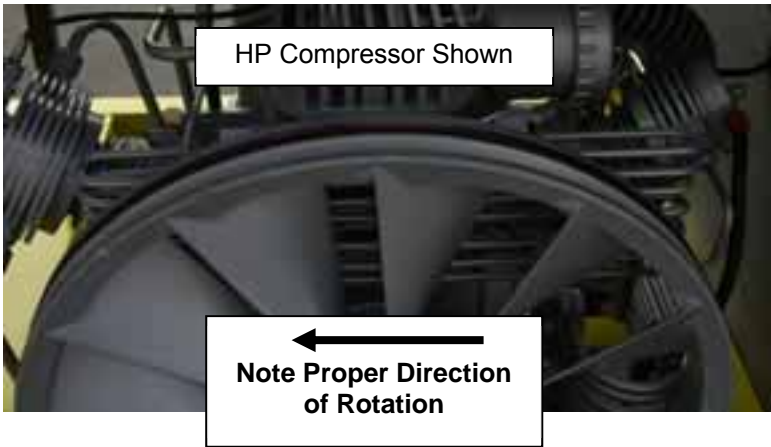

Notice

Operation in reverse direction for extended periods of time will cause a Reciprocating Compressor to run hot and perform poorly and may cause permanent damage. Reverse rotation for a rotary screw compressor for even a short period of time will cause damage.

13.4 Check Compressor Lubricant Levels

Check lubricant levels before starting the LP and HP Compressors, and add lubricant as required. Use only the lubricants specified.

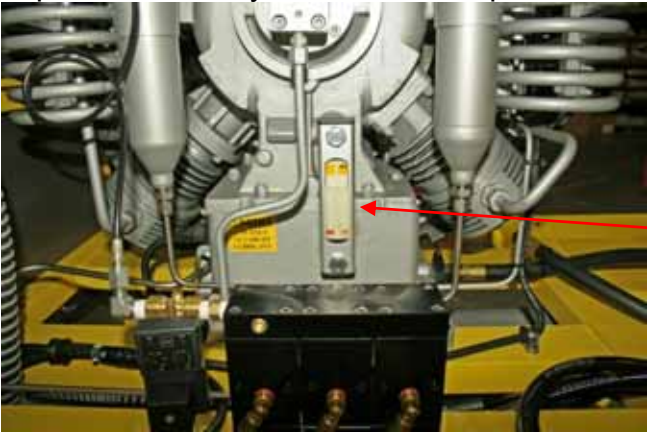

Compressor Lubricant Level Sight Gauges



LP Oil Fill & Dip Stick

Warning

Do not allow Nitrox to be discharged into the air storage system. Nitrox introduced into the air storage system could cause a diver to suffer from oxygen poisoning at depth. Oxygen poisoning is extremely dangerous and can lead to drowning.

Warning

Do not allow air to be discharged into the Nitrox storage system. Air introduced into the Nitrox storage system could cause a diver to suffer decompression sickness if the Nitrox mixture is not analyzed properly and is used underwater under the assumption it is a different mix.

13.5 Control Panel Controls

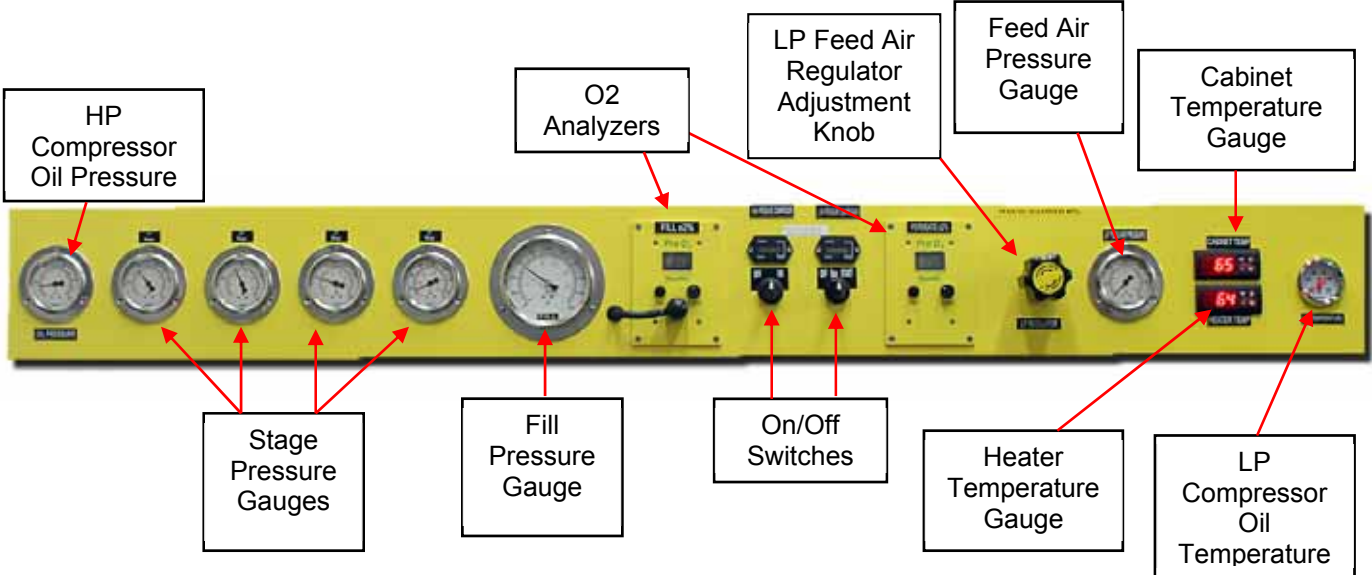

14 Pre-Operation of Compressor Before Producing Nitrox

14.1 Calibrate Oxygen Analyzers

Gas production is monitored with the Permeate Oxygen Analyzer before entering the HP Compressor to obtain a rough estimate of %O₂ (+/- 2%); however, do not rely on this reading as an indication of %O₂ at the HP Compressor outlet. Prior to pumping Nitrox from the Compressor, it must be monitored with the Fill Oxygen Analyzer to obtain a precise measurement of %O₂ (+/- 1%). **Both Oxygen Analyzers must be calibrated prior to each use.**

Warning

Oxygen Analyzers must be calibrated before each use. See Oxygen Analyzer manuals for correct calibration procedures. Improper calibration of the Fill Oxygen Analyzer may result in the use of incorrect Nitrox mixtures, which may cause serious injury or death to the diver using the gas mixture.

Warning

At altitudes above sea level, a correction factor must be used when calibrating the Fill Oxygen Analyzer may not be achievable. See Fill Oxygen Analyzer manual for correcting analyzer readings at various altitudes. Improper calibration of the Fill Oxygen Analyzer may result in the use of incorrect Nitrox mixtures, which may cause serious injury or death to the diver using the gas mixture.

Warning

The Permeate Oxygen Analyzer supplies oxygen readings that can vary +/- 2% O₂ due to heat, humidity, and pressure changes experienced in the Nitrox flow and therefore should only be used for rough estimates of %O₂. The Fill Oxygen Analyzer supplies more accurate oxygen readings, within +/- 1% O₂. For Scuba cylinder Nitrox fills, the user must always verify the final fill with a third independent Oxygen Analyzer.

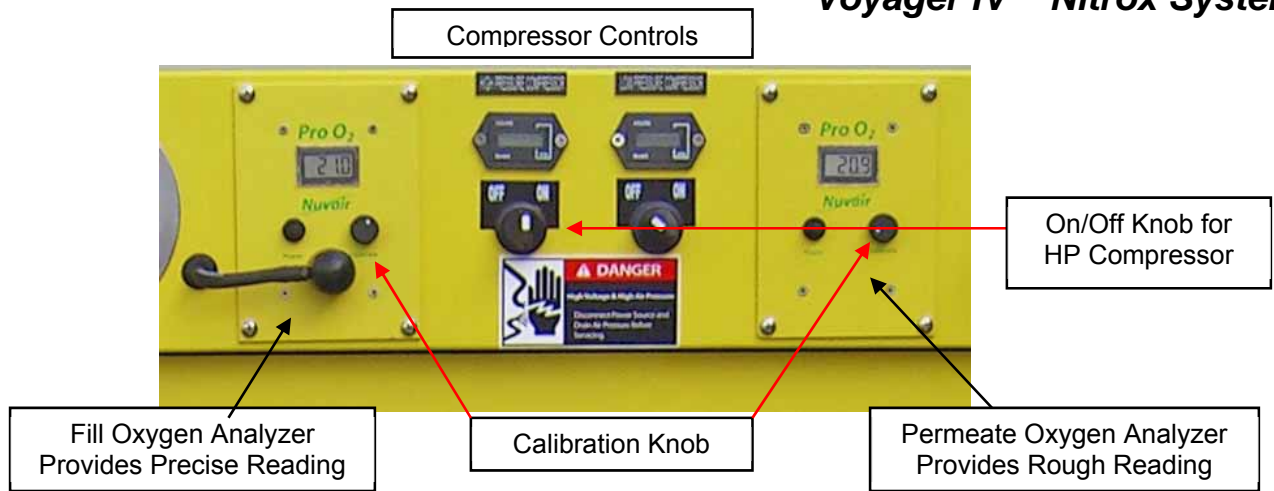

- 1) Turn on the High Pressure Compressor and allow to run for 1-2 minutes or until Analyzers stabilize.
- 2) Crack open the bleed valve on the side of the compressor so that the running HP Compressor maintains 1500-2000 P.S.I. (100-400 bar) outlet pressure. Air will now be flowing past both Oxygen Analyzers for calibration purposes.
- 3) Monitor all gauges for proper operating range and check all connections for leaks.(page 20)
- 4) Calibrate Oxygen Analyzers while the HP Compressor is pumping air. Refer to the Oxygen Analyzer manual included with the Nitrox System for details. Note that special calibration procedures may be required when operating at altitudes above sea level.
 - ◆ Permeate Oxygen Analyzer – Turn calibration knob so display reads 20.9%.
 - a. Fill Oxygen Analyzer – Remove the Flow Adapter Cap covering the Sensor.
 - b. Expose the Sensor to ambient air for approximately 15 seconds.
 - c. Adjust Calibration Knob until Display reading stabilizes at 20.9%.
 - d. Reinstall the Flow Adapter Cap to the analyzer.
 - e. The Fill Oxygen Analyzer is now ready for use.
Different settings may be used depending on location, so verify your actual ambient conditions and refer to the Oxygen Analyzer manual for details.
- 5) Turn on the LP Compressor and increase the pressure to a minimum of 90 P.S.I.
- 6) Allow the Compressors to run for a 10 Minute warm up period for the Membranes to warm up and stabilize. Check the Heater Temperature Gauge to verify air temperature rises and is between 105-120 °F (40-49 °C).
- 7) Turn off LP Compressor and Re-Calibrate The Fill Analyzer..
- 8) Now that the System Temperature has stabilized You must Re-Calibrate the Fill O₂ Sensors. See Step 4a above.

Fill Oxygen Analyzer



Sensor Cap Removed

Calibration Knob

⚠ Notice

The Oxygen Analyzers may require re-calibration after 10-20 minutes of operation due to humidity and temperature change effects on the Sensor. To recalibrate, Turn off the LP Feed Air and follow calibration instructions.

15.0 Producing Nitrox

Before using your Nitrox System to pump Nitrox, test a sample of the Nitrox produced using the Air/Nitrox Quality Analysis Kit provided to verify compliance with CGA standards. Quarterly testing is mandatory once the System is operational.

Warning

The equipment you will be using to manufacture Nitrox (oxygen rich air) will expose you to both low and high-pressure gas. Gas, even under moderate pressures, can cause extreme bodily harm. Never allow any gas stream to be directed at any part of your body.

Notice

Do not change the temperature setting on the Thermostat Control without contacting Nuvair. Changes in temperature settings may cause Membrane damage. A damaged membrane will not produce the correct Nitrox mixture which can lead to severe personal injury if the gas is used for diving purposes without proper analysis.

15.1 Flow to Membrane and Setting Proper Pressure

The Membrane System feed air pressure determines the %O₂ of the Nitrox mixture. As pressure is increased, a higher %O₂ Nitrox is pumped. As pressure is decreased, a lower %O₂ is pumped.

- 1) Increase pressure by slowly turning the regulator Knob CW while monitoring the LP Pressure Gauge and Permeate Oxygen Analyzer. As the pressure rises, watch the corresponding increase in the analyzer %O₂ reading.
- 2) Increase or decrease pressure slowly until the Permeate Oxygen Analyzer displays the %O₂ desired in the final Nitrox mixture.
 - ◆ Regulated Membrane System pressure range should be 80– 175 P.S.I (11-12 bar), depending on Nitrox %O₂ being produced.
 - ◆ Heater temperature range should be 105-120 °F (40-49 °C).

15.2 Final Adjustments Before Pumping Nitrox

- 1) As the Nitrox initially makes its way through the running HP Compressor, the %O₂ reading on the Fill Oxygen Analyzer will slowly increase to read approximately the same %O₂ as the Permeate Oxygen Analyzer. This should happen within 3-5 minutes.
- 2) When the two analyzers read within +/- 1%, make any final adjustments to the Membrane System feed air pressure necessary to obtain the exact Nitrox %O₂ desired as indicated on the Fill Oxygen Analyzer.
- 3) The system is now ready to pump Nitrox.
- 4) Now you're ready to close Bleed Valve and open Storage System.

Permeate Oxygen Analyzer



Fill Oxygen Analyzer

Warning

The use of enriched air Nitrox does not eliminate the risk of decompression sickness (DCS) in diving. Decompression sickness can lead to permanent disability or death.

Warning

The Permeate O₂ Analyzer supplies oxygen readings that can vary +/- 2% O₂ due to heat, humidity, and pressure changes in the Nitrox flow and should only be used for rough estimates of %O₂. The Fill O₂ Analyzer supplies more accurate readings, within +/- 1% O₂. For Scuba cylinder fills, the user must always verify the fill with a third independent O₂ analyzer.

Warning

Do not use this system to produce Nitrox mixtures containing more than 40% oxygen. Pumping Nitrox mixtures with higher concentrations of oxygen may lead to fires or explosions, which can cause serious personal injury or death.

Warning

Do not pump Nitrox mixtures at pressures above the HP Compressor rating, and never above 3600 P.S.I. (250 bar). The system is not rated for pressures above 3600 P.S.I. (250 bar). Higher pressures may lead to explosions which may cause serious personal injury or death.

Notice

No oxygen cleaning of standard cylinders or plumbing is mandatory when using the Nitrox System to produce Nitrox containing a maximum of 40% oxygen. When filling oxygen clean cylinders, hyper-purification of the Nitrox is required using an optional Oxygen Compatible Air purification system available from Nuair.

Danger

This Nitrox System does not produce Nitrox mixtures acceptable for 100% oxygen service.

Danger

Never fill a cylinder that is marked, "For Oxygen Service," with Nitrox that has been produced by anything other than 100% oxygen clean system. Filling an oxygen clean cylinder with breathing gas containing hydrocarbons can lead to explosions if the cylinder is subsequently filled with gas mixtures containing gas mixtures containing greater than 40% oxygen.

Warning

Only provide Scuba cylinder Nitrox fills to customers who have proof of Nitrox training and certification. Improper use of Nitrox can be fatal.

 **Danger**

This system is not cleaned for oxygen service and not all components are compatible with gas mixtures containing greater than 40% oxygen. Pumping gas mixtures containing greater than 40% oxygen will lead to explosions which may cause severe personal injury or death.

 **Warning**

Each Scuba cylinder belonging to a customer must be analyzed by that customer at the Nitrox filling facility, using an oxygen analyzer independent of those used with the Nitrox System. An employee must witness that the customer has properly analyzed the gas in each cylinder, noted the maximum operating depth for that mixture, and signed and dated the fill log. The time of day must also be included with the date, since some customers may fill the same cylinder more than once a day.

15.3 Pumping Nitrox

- 1) When filling a Scuba cylinder, follow all industry standards. Do not exceed rated pressure of cylinder, and do not exceed 3600 P.S.I. (250 bar) under any condition.
- 2) With fill whip bleed valve open and Nitrox flowing, verify that Fill Oxygen Analyzer %O₂ reading equals the desired Nitrox %O₂.
- 3) Close bleed valve, open cylinder valve, and fill cylinder. Monitor system for proper operation:
 - a) Monitor Oxygen Analyzers and recalibrate as required
 - b) Listen for proper operation of automatic condensate drains every 10-15 minutes.
 - c) Monitor all system gauges as shown in the table below.

 **Notice**

The Oxygen Analyzers may require re-calibration after 10-20 minutes of operation due to humidity and temperature change effects on the Sensor. To recalibrate, turn off the LP Feed Air Switch and follow calibration instructions.

 **Notice**

When the HP Compressor auto drain engages and dumps condensate, the Fill Oxygen Analyzer reading will decrease momentarily due to the pressure drop in the system. It will return to its previous reading within seconds after the auto drain sequence stops.

GAUGE	RECOMMENDED SETTING
Compressor Gauges	According to manufacturers recommendations
Heater Temperature	105-120° F (40-49° C)
Cabinet Temperature	Less than 100° F (38° C)
Membrane Feed Air Pressure	80 - 175psi (6-12 bar) depending on Nitrox O ₂ %
Fill Oxygen Analyzer	Showing the proper reading for intended fill
Nitrox Storage Pressure	<u>DO NOT</u> exceed rating of tank or 3600 P.S.I (250 bar)

15.1 Pumping Nitrox (continued)

- 4) After filling is complete, close cylinder valve, vent the bleed valve, and remove the cylinder.
- 5) Test the Nitrox %O₂ in the cylinder using an independent Oxygen Analyzer such as the Nuair O₂ Quickstick™. Calibrate analyzer before use in accordance with manufacturer's instructions.
- 6) Repeat steps 1-5 until you have filled all Scuba cylinders.
- 7) Mark each tank with fill date, %O₂, fill pressure, and MOD (Maximum Operating Depth).
- 8) Log every Nitrox fill to document the following information:
 - ◆ Fill date and time of day
 - ◆ Tank Number
 - ◆ Supplier's check of oxygen content (%O₂) plus signature and date
 - ◆ User's check of oxygen content (%O₂) plus signature and date
 - ◆ Fill Pressure
 - ◆ MOD (Maximum Operating Depth) in user's handwriting
 - ◆ Nitrox certifying agency and card number
- 9) When filling a HP Nitrox storage tank, verify that Fill Oxygen Analyzer %O₂ reading equals the desired Nitrox %O₂. Open applicable line valves and tank valve, and fill with Nitrox. Do not exceed rated pressure of cylinder, and do not exceed 3600 P.S.I. (250 bar) under any condition. After filling is complete, close all valves and allow Nitrox System to shut down.



Use Independent Oxygen Analyzer for Verification

15.2 Pumping Air

To use the System to pump air, simply turn off the LP Compressor. No Nitrox will be supplied to the HP Compressor, and it will pump air only. When the HP Compressor is pumping air, the Permeate Oxygen Analyzer and the Fill Oxygen Analyzer should both read 20.9% O₂.



On/Off Switches

On/Off Knob for HP Compressor

LP Compressor Control

⚠ Notice

Always use Oxygen Analyzers to monitor oxygen content of any gas flowing through the System. Both air and Nitrox are subject to variations in oxygen content.

15.3 Shutting Down

- 1) When the Storage Banks are finished filling and tank valves are closed, the Nitrox System will automatically shut down at the pressure set on the pressure switch (3600 psi).
- 2) Manually shut off the Membrane System by turning the Feed Air Regulator adjustment knob CCW to reduce pressure to minimum setting and then turn off the LP & HP compressors.
- 3) The system will automatically drain all Filter, Compressor, and Volume Tank condensate.

16.0 Nitrox Operation Notes

16.1 Correlation of Feed air Pressure to Oxygen Content

After the 10 hour break-in period for your Nitrox System, you will notice that specific Nitrox %O₂'s always match specific feed air pressures once the System has warmed up. These pressures will be repeatable. If you find that the Fill Oxygen Analyzer reads 36% O₂ when the feed air pressure is at 125 P.S.I. (9 bar), record this pressure or make a mark on the feed air pressure gauge indicating the %O₂. Do this for each %O₂ that you normally make, making sure System has warmed up first. The next time Nitrox with 36% O₂ is needed, adjust the regulator to 125 P.S.I. (9 bar) and wait for the Oxygen Analyzer reading to stabilize. You will find the analyzer reading to be very close to 36% O₂, requiring only minor adjustments of the regulator to achieve the exact desired %O₂.

Notice

Use the Fill Oxygen Analyzer to verify the Nitrox oxygen percentage prior to pumping. When using the feed air pressure reading to obtain specific oxygen percentage, minor adjustments of the feed air pressure regulator may be required to obtain the exact percentage desired.

16.2 Hot Fills

While in the process of filling HP Nitrox Storage Tanks, you may have a need to supply a walk-in customer with a Scuba Cylinder fill of a different Nitrox mix. You can change mixes as follows:

- 1) With the Nitrox System operating, isolate the HP Nitrox Storage Tanks from the HP Compressor by closing the appropriate valves.
- 2) Record the Membrane System feed air pressure reading.
- 3) Slightly open fill whip valve on the HP Compressor, and adjust so the running Compressor maintains 1500-2000 P.S.I. (100-140 bar) outlet pressure.
- 4) Adjust the B.P. feed air regulator to the pressure corresponding to the desired Nitrox %O₂ for the Scuba Cylinder fill.
- 5) Allow the Fill Oxygen Analyzer reading to stabilize, make any minor adjustments necessary to achieve the desired %O₂, and then fill cylinder in normal manner.
- 6) When finished return regulator to previous setting, and allow the Fill Oxygen Analyzer reading to stabilize. Make any minor adjustments necessary to achieve the desired %O₂, and then resume filling Storage Tanks.

17.0 Maintenance

The following list of daily and routine maintenance items is intended as a guide. Refer to LP and HP Compressor manuals for complete maintenance requirements.

17.1 Daily Maintenance

Caution

Be sure to check Compressor Lubricant levels prior to each day of operation. Failure to ensure the proper lubricant level will lead to system damage.

- 1) Check lubricant levels of both LP and HP Compressors and add proper lubricants as required. See Section 17.3 and Compressor manuals for details.
- 2) Slightly open each HP and LP Manual Condensate Drain Valve to verify that no condensate is present.
- 3) Check LP Air Filtration for condensate and proper operation of condensate drains.

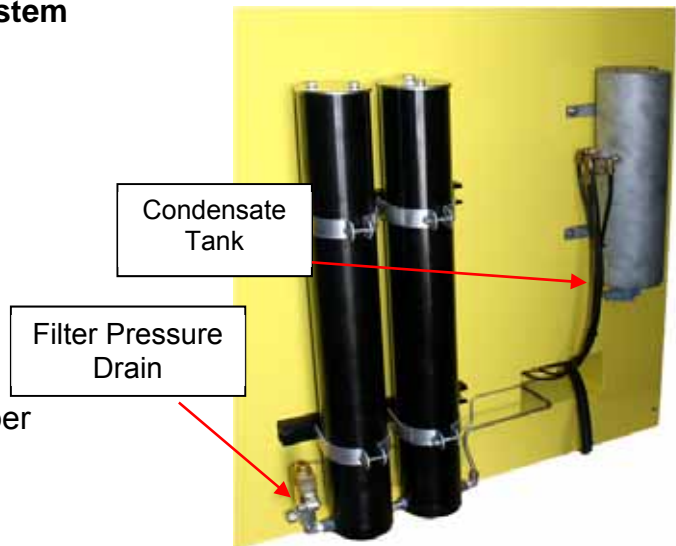

Warning

Use only the specified Nuvair Lubricants in this system. The use of incompatible lubricants presents a risk of fire and/or explosion, and may result in system damage. This can lead to severe personal injury and death.

Warning

Be sure that all pressure has been relieved from the system prior to opening any filtration canister. Failure to vent pressure from the system prior to opening the canister can lead to serious personal injury or death.

Caution

If system is located in an area where there is high humidity and high heat, the life of all Filtration Elements may be as little as 35% of rated operating capacity. Check the Compressor manual and Appendix for details on Filter Element Life Factors.

15.1 Routine Maintenance

- 1) LP Compressor Lubricant: Change Compressor Lubricant every 1000 hours or annually. Only use lubricants rated for use with Nitrox, such as Nuvair 546™. Never mix Compressor Lubricants. See Section 17.3 and LP Compressor manual for details.
- 2) HP Compressor Lubricant: Change Compressor Lubricant every 100 hours or annually, whichever comes first. Only use lubricants rated for use with Nitrox, such as Nuvair 455™. Never mix Compressor Lubricants. See Section 17.4 and HP Compressor manual for details.
- 3) LP Air Filtration Inspection: On a weekly basis, inspect each Filter Bowl for the presence of moisture and each Element for any unusual degradation or wetness. See Section 17.5 for details.
- 4) LP Air Filtration Elements: Change LP Filter Elements every 500 hours or annually to maintain CGA Grade D air standards. Visual liquid level and service life indicators assist with monitoring replacement intervals. See Section 17.5 for details. If the Nitrox System is operated in high humidity and/or high temperature, Filter Elements must be changed more often. See Appendix for details on Filter Element Life Factors.
- 5) HP Compressor Filtration Element: Change HP Filter Element every 60,000 cubic feet of air or Nitrox processing to maintain CGA Grade E air standards. See Section 17.6 for details. If the Nitrox System is operated in high humidity and/or high temperature the Filter Element must be changed more often. See Appendix for details on Filter Element Life Factors.
- 6) Condensate Drain Container: Check level and drain weekly or as needed.
- 7) Semi-Permeable Membrane: No maintenance required. Service life exceeds 20 years if LP Air Filtration is properly serviced to maintain Grade D standards.
- 8) Membrane System Air Intake Filter: Inspect filter element every 3 months for visible particles. Change every 12 months or sooner if particles are visible.
- 9) Oxygen Analyzers: Replace Oxygen Sensor and Battery as required. See manual included with Nitrox System.
- 10) Air/Nitrox Quality Analysis: Take breathing air/Nitrox samples quarterly for analysis to assure compliance with CGA Grade E breathing air standards.



Condensate Drain Container.
Check & Drain Weekly.

Danger

Do not swallow (ingest) either the electrolyte from the Oxygen Sensor or the Sensor itself. The Potassium Hydroxide chemical contained in the Sensor can cause severe injury or death. If electrolyte or the Sensor is swallowed, seek medical attention immediately.

Danger

If after handling the Oxygen Analyzer or Sensor, you find that your fingers or other parts of your body feel “slippery” or the skin or eyes sting, immediately flush affected area with clean, fresh water for at least 15 minutes. The stinging or slippery sensation is an indication of a

leaking Sensor. The Potassium Hydroxide chemical contained in the Sensor can cause severe injury or death. Seek immediate medical attention if eye contact is made or skin stinging persists.

Warning

Use only the specified Nuair Lubricants in this system. The use of incompatible lubricants presents a risk of fire and/or explosion, and may result in system damage. This can lead to severe personal injury and death.

17.3 Compressor Lubricant (see page 38 -41 for material spec sheets)

- ◆ The LP Compressor in your Nitrox System comes standard with Nuair 546™ Synthetic Food Grade Compressor Lubricant for Rotary Screw Compressors.
- ◆ The HP Compressor comes with the Nuair 455 Synthetic Food Grade Lubricant. Check lubricant levels at each Sight Gauge and add lubricant as required through the appropriate Fill Plug. Lubricant is removed through the Drain Plugs. See LP and HP Compressor manuals for details on servicing Lubricant

Never mix lubricants they are different.

Danger

Do not carry out these tasks if the compressor has only just shut down; wait for the compressor to cool. Pressure must be drained before opening LP Fill Plug.

Any oil spilt during the oil/filter change could cause personnel to slip; wear protective garments and anti-slip footwear and remove traces of oil immediately.

Both oil and filter are classified as special wastes and must therefore be disposed of in compliance with the anti-pollution laws in force.

All maintenance work must be carried out with the compressor OFF and the power supply lead unplugged from the main socket.



Lubricant
Fill Plugs



17.4 LP Feed Air Filtration

⚠ Caution

Special attention needs to be given to the arrangement of the four LP Feed Air Filtration Elements and Bowls. Properly reinstall each Element and Bowl to the correct Housing. Improper sequence can cause damage to downstream components

The use of Grade D or better feed air is critical to prevent the passing of any residual oil vapor into the Membrane System. Four stages of Hankison LP filtration are used to produce Grade D air:

- 1) Coalescing Filter
- 2) Coalescing & Water/Oil Vapor Removal to 1 Particulate micron
- 3) Coalescing & Water/Oil Vapor Removal to 0.01 Particulate micron
- 4) Final Stage - Oil Vapor Removal to 0.003 PPM

LP Filtration Inspection

Open each Filter and inspect as follows:

- 1) Inspect Bowl for the presence of moisture. A high level of moisture build-up in the HF11-24 or HF7-24 Filter indicates improper operation of auto-drain floats. Evidence of any moisture in the HF1=24 Filter indicates air is not cooling properly and moisture is not properly being removed. Check HF1 canister weekly for moisture. Moisture indicates possible refrigerated dryer problem. Excess moisture will prevent the final filter from operating properly and can lead to damage of the membrane.

← Air Flow

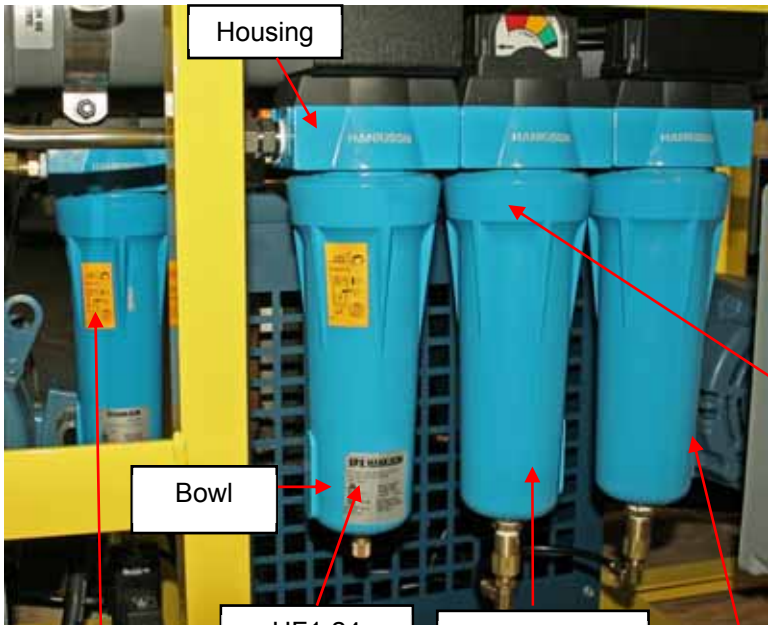

HF1-24 Oil Vapor Removal	HF5-24 Coalescing & Water/Oil Vapor Removal	HF7-24 Particle & Moisture Removal	HF11-24 Coalescing
Replacement Element Part Number			
E1-24	E5-24	E7-24	E11-24

- HF11-24 Filter with Auto-Drain Float & Liquid Level Indicator
- HF1-24 Filter with Manual Drain – Should not Contain Moisture
- HF5-24 Filters with Auto-Drain Float & Liquid Level/ Service Indicators
- HF7-24 Filter with Auto-Drain Float & Liquid Level Indicator

Changing LP Filtration Elements

Change Filter Elements every 500 hours. If the Nitrox System is operated in high humidity and/or high temperature, Filter Elements must be changed more often. See Appendix for details on Filter Element Life Factors. Visual service indicators on the HF7 & HF5 filters assist with monitoring replacement intervals.

- 1) Push up on Filter Bowl, rotate counter-clockwise, and lower to remove.
- 2) Gently unscrew Filter Element and pull down off mounting post.
- 3) Replace Element and reassemble in reverse order.



Changing LP
Filtration
Element

Notice

The interior of the Filter Bowls can be cleaned with a diluted solution of Simple Green™ and flushed thoroughly with clean water. This will assist to prolong the life of the element, bowl, and auto drain.

17.5 HP Compressor Filtration

The HP Compressor comes standard with Triplex filtration, utilizing a single Filter Element. Do **NOT** use any substitute. Change Filter Element every 60,000 cubic feet of air or Nitrox processing. If the Nitrox System is operated in high humidity and/or high temperature, Filter Element must be changed more often. See Appendix for details on Filter Element Life Factors.

- 1) Shut down the Nitrox System
- 2) Open Manual Bleed Drain Valve to drain pressure. Leave Valve open.
- 3) Unscrew the Filter Canister Cap.
- 4) Remove expended Element from Filter Canister.
- 5) Install New Element place pressure on element to seat the element.
- 6) Reinstall Cap to Canister.
- 7) Close Manual Condensate Valves.

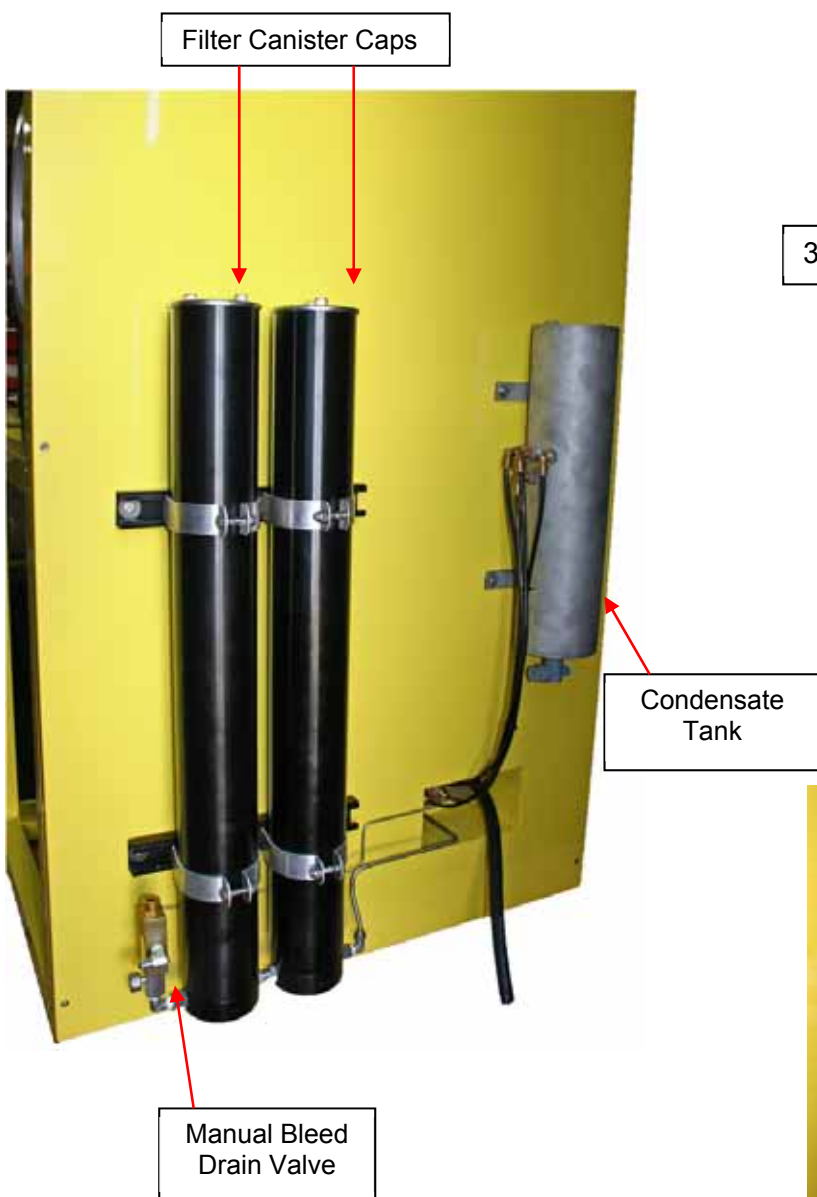

17.6 Spare Parts List

See LP and HP Compressor manuals for Compressor parts lists. Other Nitrox System components and related items are listed below.

Nitrox System Components	Type	Part Number
LP Compressor Consumables		
Rotary Screw Compressor Lubricant, Food Grade, Nitrox Compatible	Nuvair 546, 1 Gal	9409
LP Filtration Element	Hankison HF11-24	E11-24
	Hankison HF7-24	E7-24
	Hankison HF5-24	E5-24
	Hankison HF1-24	E1-24
HP Compressor Consumables		
HP Compressor Lubricant, Food Grade, Nitrox Compatible	Nuvair 455, 1 Gal	9406
HP Compressor Filtration Element	Gas Drying Filter	X65677
	Breathing Air Filter, Grade E	X65247
Heater Assembly	1200 Watt, 28" Length	H1200
Heater Thermostat Control	220V Fahrenheit Gauge standard	TS-13020 F TS-13021 C
Heater Pressure Switch		B16-947
Membrane	230 Series	PPA230
Air Intake Filter Element	10-20 CFM	18P
Mixing Tube Assembly	1.5 in diameter, specify length	Call for part.
Oxygen Analyzer	Pro O ₂	9460
	Pro O ₂ Remote	9462
Oxygen Sensor	Pro O ₂ Pro O ₂ Remote	9505 9506
Compressor Hose Coupler	1-1/4"-1-1/2" to 1-1/4"-1-1/2"	018578000476
	1-1/4"-1-1/2" to 1-1/2"	RDTC40X32
Related Equipment Components		
Air/Nitrox Quality Analysis Kit	Specify: (1) CGA Grade Required	
	(2) Single Use or Program Use	

Appendix

Supply and Breathing Air Specifications

All supply and breathing air must meet the following requirements of CGA G-7.1-1997. Supply air delivered to the Membrane System must be purified to meet Grade D or E quality, and periodic air quality testing to assure compliance is recommended. All breathing air for diving produced by the downstream Compressor must be purified to meet Grade E quality, and periodic air quality testing to assure compliance is mandatory.

Item	Grade D	Grade E
Oxygen	19.5-23.5%	20-22%
Carbon Dioxide (maximum)	1000 PPM	1000 PPM
Carbon Monoxide (maximum)	10 PPM	10 PPM
Hydrocarbons (maximum)	Not specified	25 PPM
Water Vapor (maximum)	Not specified	Not specified
Dew Point (maximum) (1)	Not specified	Not specified
Oil & Particles (maximum) (2)	5 mg/m3	5 mg/m3
Odor	None	None

Notes: (1) Dew Point of supply air must be >10°F (6°C) colder than coldest ambient air expected
 (2) Supply air delivered to the Membrane System must contain <0.003 PPM Oil Vapor

All breathing Nitrox produced for diving must be purified to meet these same requirements, except for oxygen content. Nitrox oxygen content must measure within +/- 1% O₂ of the specified value of the mixture using a properly calibrated Oxygen Analyzer (i.e. Nitrox produced with a target content of 32% O₂ must measure in the range of 31-33% O₂). Periodic air quality testing to assure compliance is mandatory.

Filter Element Life Factors

Breathing air filter element life is typically rated by manufacturer based on an air temperature of 80°F at the filter inlet. Under normal operation this temperature is 12°F (5°C) warmer than the ambient air, resulting in an equivalent ambient temperature rating at 68°F (20°C).

To determine element life at a different ambient temperature, multiply the rated life by the life factor listed below:

Filter Temperature	Ambient Temperature	Filter Element Life Factor
53°F (12°C)	41°F (5°C)	2.6 x Life
62°F (17°C)	50°F (10°C)	1.8 x Life
71°F (23°C)	59°F (16°C)	1.35 x Life
80°F (27°C)	68°F (20°C)	1 x Life
89°F (32°C)	77°F (25°C)	0.8 x Life
96°F (36°C)	84°F (29°C)	0.55 x Life
105°F (41°C)	93°F (34°C)	0.45 x Life
114°F (46°C)	102°F (39°C)	0.35 x Life

Material Safety Data Sheets

Nuvair™ 455 Premium Synthetic Food Grade Air/Nitrox Compressor Lubricant

Effective Date: 03/19/2010

I. Product Identification:

Trade Name: Nuvair 455
 Chemical Name: Polyalphaolefin
 Chemical Family: Synthetic hydrocarbons/Esters

II. Components & Hazard Statement:

This product is non-hazardous. This material is not considered hazardous by the OSHA Hazard Communication Standard (29 CFR 1910.1200).

III. Physical Data:

Viscosity: 100 cst. @40°C
 Specific Gravity (Water = 1.0): 0.85
 Boiling Point: N.A.
 Vapor Pressure: Negligible
 Appearance & Odor: Clear – with Mild odor
 Solubility in Water: Negligible

IV. Fire & Explosion Hazard Data:

Flash point: 464°F / 24°C/ COC
 Auto ignition Temperature: Not Established
 Flammability Limits: Not Established
 Extinguishing Media: Dry Chemical; CO2 Foam; Water Spray
 Special Fire Fighting Procedure: Burning may produce irritating/noxious fumes. Firefighters should use NIOSH/MNSA approved self-contained breathing apparatus. Use water to cool fire-exposed containers to prevent pressure build-up.

V. Reactivity Data:

Stability: This product is stable and will not react with water.
 Materials to Avoid: Avoid strong oxidizers
 Hazardous Decomposition Products: Carbon monoxide, Carbon dioxide

VI. Health Information:

Eye Contact: Flush eyes with water for 15 minutes. Call physician if irritation develops.
 Skin Contact: Wash skin with soap and water.
 Inhalation: Remove to fresh air.
 Ingestion: First aid not normally required. If uncomfortable, call physician.

VII. Health Hazard Data:

Exposure Limit: Not Applicable
 Effects of Overexposure: Low oral and dermal toxicity. Prolonged or repeated exposure may cause irritation, nausea, and vomiting.

VIII. Employee Protection:

For general personal hygiene, wash hands thoroughly after handling material. Avoid contact with skin and eyes. Chemical impervious gloves are not required, but may be recommended for prolonged exposure. Use in a well ventilated area.

IX. Storage, Spill, & Disposal Procedures:

Storage: Store in clean, dry area.
 Spills: Use absorbent materials to soak up fluid.
 Disposal: Incinerate this product and all associated wastes in a licensed facility in accordance with Federal, state, and local regulations.

X. Hazard Rating Information:

NFPA Health: 0
 Flammability: 1
 Reactivity: 0
 Personal Protection: B

This information contained herein is based on the data available to us and is believed to be true and accurate. Nuvair makes no warranty, expressed or implied, regarding the accuracy of this data or the results to be obtained from the use thereof. Nuvair assumes no responsibility for injury from the use of this product.

Material Safety Data Sheet

Nuvair™ 751 Premium Synthetic Diester Based Air/Nitrox Compressor Lubricant

Effective Date: 3/10/2010

Supersedes:

I. Product Identification:

Trade Name: Nuvair 751
 Chemical Name: Diester
 Chemical Family: Diester

II. Components & Hazard Statement:

This product is non-hazardous. This material is not considered hazardous by the OSHA Hazard Communication Standard (29 CFR 1910.1200).

III. Physical Data:

Viscosity: 146 cst. @40°C
 Specific Gravity (Water = 1.0): 0.94
 Boiling Point: Not determined
 Vapor Pressure: Negligible
 Appearance & Odor: Amber / Mild odor
 Solubility in Water: Negligible
 Other Data: Non-toxic USDA H-2 approved

IV. Fire & Explosion Hazard Data:

Flash point: 520°F / 271°C COC ASTM D-92
 Autoignition Temperature: 765°F ASTM D-2155
 Flammability Limits: Not Established
 Extinguishing Media: Dry Chemical; CO2 Foam; Water Spray
 Special Fire Fighting Procedure: Burning may produce irritating/noxious fumes. Firefighters should use NIOSH/MNSA approved self-contained breathing apparatus. Use water to cool fire-exposed containers to prevent pressure build-up.

V. Reactivity Data:

Stability: Stable under normal conditions.
 Materials to Avoid: Incompatible with oxidizing agents.
 Hazardous Decomposition Products: Carbon monoxide, Carbon dioxide

VI. Health Information:

Eye Contact: Flush eyes with water for 15 minutes. Call physician if irritation develops.
 Skin Contact: Wash skin with soap and water.
 Inhalation: Remove to fresh air.
 Ingestion: First aid not normally required. If uncomfortable, call physician.

VII. Health Hazard Data:

Exposure Limit: Not Applicable
 Effects of Overexposure: Low oral and dermal toxicity. Prolonged or repeated exposure may cause irritation, nausea, and vomiting.

VIII. Employee Protection:

For general personal hygiene, wash hands thoroughly after handling material. Avoid contact with skin and eyes. Chemical impervious gloves are not required, but may be recommended for prolonged exposure. Use in a well ventilated area.

IX. Storage, Spill, & Disposal Procedures:

Storage: Store in clean, dry area.
 Spills: Use absorbent materials to soak up fluid.
 Disposal: Incinerate this product and all associated wastes in a licensed facility in accordance with Federal, state, and local regulations.

X. Hazard Rating Information:

NFPA Health: 0
 Flammability: 1
 Reactivity: 0
 Personal Protection: B

This information contained herein is based on the data available to us and is believed to be true and accurate. Nuvair makes no warranty, expressed or implied, regarding the accuracy of this data or the results to be obtained from the use thereof. Nuvair assumes no responsibility for injury from the use of this product.

Material Safety Data Sheet

Nuvair™ 546 Premium Synthetic Food Grade Air/Nitrox Compressor Lubricant

Effective Date: 03/19/2010

Supersedes:

I. Product Identification:

Trade Name: Nuvair 546
 Chemical Name: Polyalphaolefin
 Chemical Family: Synthetic hydrocarbon

II. Components & Hazard Statement:

This product is non-hazardous. This material is not considered hazardous by the OSHA Hazard Communication Standard (29 CFR 1910.1200)

III. Physical Data:

Viscosity: 46 cSt. @ 40°C
 Specific Gravity (Water = 1.0): 0.84
 Boiling Point: Not Determined
 Vapor Pressure: Negligible
 Appearance & Odor: Clear & odor Mild
 Solubility in Water: Negligible
 Other Data: Non-Toxic USDA H-1 Approved

IV. Fire & Explosion Hazard Data:

Flash point: 500°F / 260°C
 Autoignition Temperature: Not Determined
 Flammability Limits: Not Determined
 Extinguishing Media: Dry Chemical; CO2 Foam; Water Spray
 Special Fire Fighting Procedure: Burning may produce irritating/noxious fumes. Firefighters should use NIOSH/MNSA approved self-contained breathing apparatus. Use water to cool fire-exposed containers to prevent pressure build-up.

V. Reactivity Data:

Stability: Stable under normal conditions.
 Materials to Avoid: Incompatible with oxidizing agents.
 Hazardous Decomposition Products: Carbon monoxide, Carbon dioxide

VI. Health Information:

Eye Contact: Flush eyes with water for 15 minutes. Call physician if irritation develops.
 Skin Contact: Wash skin with soap and water.
 Inhalation: Remove to fresh air.
 Ingestion: First aid not normally required. If uncomfortable, call physician.

VII. Health Hazard Data:

Exposure Limit: Not Applicable
 Effects of Overexposure: Low oral and dermal toxicity. Prolonged or repeated exposure may cause irritation, nausea, and vomiting.

VIII. Employee Protection:

For general personal hygiene, wash hands thoroughly after handling material. Avoid contact with skin and eyes. Chemical impervious gloves are not required, but may be recommended for prolonged exposure. Use in a well ventilated area.

IX. Storage, Spill, & Disposal Procedures:

Storage: Store in clean, dry area.
 Spills: Use absorbent materials to soak up fluid.
 Disposal: Incinerate this product and all associated wastes in a licensed facility in accordance with Federal, state, and local regulations.

X. Hazard Rating Information:

NFPA Health: 0
 Flammability: 1
 Reactivity: 0
 Personal Protection: B

This information contained herein is based on the data available to us and is believed to be true and accurate. Nuvair makes no warranty, expressed or implied, regarding the accuracy of this data or the results to be obtained from the use thereof. Nuvair assumes no responsibility for injury from the use of this product.

OWNER'S WARRANTY RESPONSIBILITIES

Failure of the owner to prevent equipment damage by complying with the procedures outlined below and in the Operation Manual will void the Nitrox System warranty.

Installation:

- All set up requirements and procedures provided in the Nitrox System Operation Manual must be followed in their entirety including supply air cleanliness, Compressor preparation, and installation of the Nitrox System.
- Supply air to the Membrane must be properly filtered to CGA Grade D air quality or better to prevent damage to the Membrane. Air quality testing of the supply air should be performed periodically and documented to assure compliance.
- If there is any doubt regarding the suitability of a HP or LP Compressor for compressing Nitrox, contact Nuair or the Compressor manufacturer before you connect your Nitrox System.
- If an existing HP or LP Compressor is to be used for compressing Nitrox, all traces of the old lubricant must be removed and replaced with a Nitrox Compressor Lubricant approved by Nuair.
- Electrical wiring and connections should be made by a qualified electrician in accordance with all national and local electrical codes.
- Do not change the temperature setting on the Heater Thermostat Control. Changes in temperature settings may cause Membrane damage.
- To prevent Compressor damage, only use the Compressor Intake Hose provided. If a longer hose is required, contact Nuair for assistance.
- Compressors must be provided adequate ventilation to operate properly and prevent heat damage. This requires an ambient temperature below 100 °F (38 °C), sufficient clearance from adjacent walls, and proper rotation direction.

Operation:

- Do not use the Nitrox System to supply a HP or LP Compressor with Nitrox mixtures containing more than 40% oxygen. Compressing higher concentrations of oxygen may cause severe Compressor damage.
- Do not pump Nitrox mixtures at pressures above the Compressor manufacturer's rating, and never above 3600 P.S.I. (250 bar). Compressing Nitrox at higher pressures may cause severe HP Compressor damage.
- To prevent Membrane damage, drain all low pressure filter and volume tank condensate on a daily basis.
- If you become aware of an operational fault, stop using the equipment immediately and contact Nuair for assistance.

Maintenance:

- Change low pressure filter elements on a schedule determined by filter capacity and ambient temperature and humidity. Contact Nuair if you need assistance establishing a schedule for your equipment and location.
- Replace Membrane System Air Intake Filter on a regular basis to prevent flow obstruction.
- Keep all nuts, bolts, fittings, connectors, and clamps tight.
- Keep a service record book showing that regular maintenance work has been carried out. If a warranty claim becomes necessary, it will aid in demonstrating that damage has not been caused by insufficient maintenance. Proof of maintenance may be required prior to determining the validity of a warranty request.

NUVAIR NITROX SYSTEM WARRANTY

NUVAIR extends a limited warranty, which warrants the Nitrox System to be free from defects in materials and workmanship under normal use and service for a limited period. The specific Membrane Component of the Nitrox System is warranted according to the pro-rated terms as set forth below. All other Original Equipment Manufacturer (OEM) components used in the system are warranted only to the extent of the OEM's warranty to NUVAIR. NUVAIR makes no warranty with respect to these OEM components, and only warrants the workmanship that NUVAIR has employed in the installation or use of any OEM component. This warranty is not transferable.

NUVAIR will, at its discretion and according to the terms as set forth within, replace or repair any materials which fail under normal use and service and do not exhibit any signs of improper maintenance, misuse, accident, alteration, weather damage, tampering, or use for any other than the intended purpose. Determination of failure is the responsibility of NUVAIR, which will work together with the customer to adequately address warranty issues. When any materials are repaired or replaced during the warranty period, they are warranted only for the remainder of the original warranty period. This warranty shall be void and NUVAIR shall have no responsibility to repair or replace damaged materials resulting directly or indirectly from the use of repair or replacement parts not approved by NUVAIR.

Pro-Rated Terms:

NUVAIR warrants the Membrane Component of the Nitrox System to be free from defects in material and workmanship for a period of thirty-six (36) months from date of installation or forty-two (42) months from date of shipment by NUVAIR, whichever may occur first. The warranty covers parts only and is prorated as follows:

- First Year Repair or replacement free of charge
- Second Year Warranty allowance of 70% of the current Membrane Component list price
- Third Year Warranty allowance of 40% of the current Membrane Component list price

A warranty registration card, supplied with system documentation, must be filled out and submitted to NUVAIR for the warranty to be in full effect. If the warranty registration card is not received within thirty (30) days of installation, the thirty-six (36) month warranty will begin with the date of shipment from NUVAIR. For warranty service to be considered, customer's account must be current or paid in full.

Maintenance Items:

Any materials which are consumed, or otherwise rendered not warrantable due to processes applied to them, are considered expendable and are not covered under the terms of this policy. This includes maintenance and consumable items listed as part of a suggested maintenance program included with system documentation.

Return Policy:

Application for warranty service can be made by contacting NUVAIR during regular business hours and requesting a Return Material Authorization number. Materials that are found to be defective must be shipped, freight pre-paid, to the NUVAIR office in Oxnard, California. Upon inspection and determination of failure, NUVAIR shall exercise its options under the terms of this policy. Warranty serviced materials will be returned to the customer via NUVAIR's preferred shipping method, at NUVAIR's expense. Any expedited return shipping arrangements to be made at customer's expense must be specified in advance.

Limitation of Warranty and Liability:

Repair, replacement or refund in the manner and within the time provided shall constitute NUVAIR'S sole liability and the Purchaser's exclusive remedy resulting from any nonconformity or defect. NUVAIR shall not in any event be liable for any damages, whether based on contract, warranty, negligence, strict liability or otherwise, including without limitation any consequential, incidental or special damages, arising with respect to the equipment or its failure to operate, even if NUVAIR has been advised of the possibility thereof. NUVAIR makes no other warranty or representation of any kind, except that of title, and all other warranties, express or implied, including warranties of merchantability and fitness for a particular purpose, are hereby expressly disclaimed. No salesman or other representative of NUVAIR has authority to make any warranties.



Nuvair™ 2010 All Rights Reserved
Phone 1-805-815-4044
Fax 1-805-815-4196
2949 West 5th Street
Oxnard, CA 93030 USA
Email : info@nuvair.com
Web : www.nuvair.com

Revision 040912